

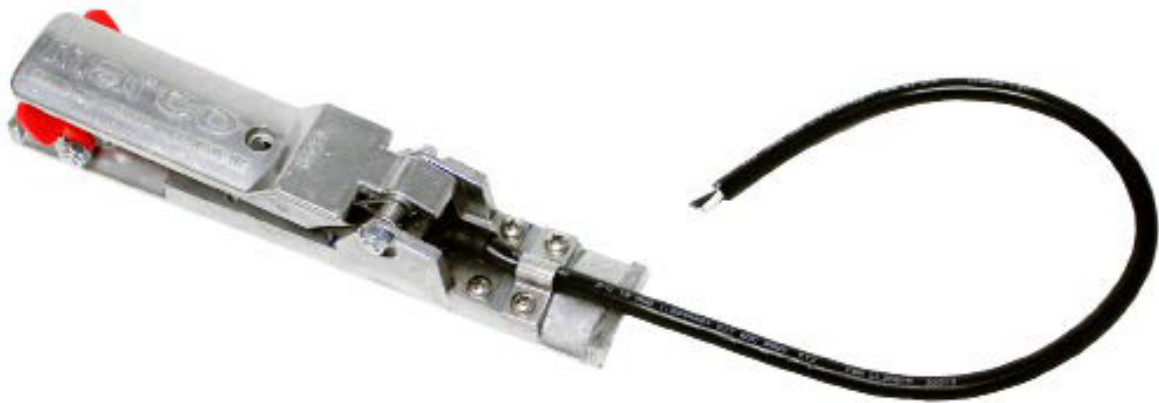

BLASTMASTER® 151E REMOTE CONTROL SWITCH



**BUILT MARCO
TOUGH**
MARCO MANUFACTURED

PART NUMBERS AND SCHEMATICS GUIDE

Company Profile

Since 1944, Marco has developed a strong tradition of providing innovative and reliable products and services to the surface preparation and protective coatings industries. We are the world's premier provider of Abrasives, Blasting Equipment, Coating Equipment, Engineered Systems, Rental Equipment, Safety Equipment, Service, and Repair.

Through innovative designs and a total commitment to quality, Marco manufactures products that increase production rates, create a safer workplace, and reduce maintenance costs. Marco's industry experience, manufacturing capabilities, legendary customer service, product availability, logistics services, and technology leadership is your assurance that we deliver high quality products and services, providing the best value to you, our customer.

The Marco Difference

- **Industry Experience** – With Marco on your team, you have access to expertise which can only come from decades of industry leadership. We have organized our engineering department, production specialists, customer operations, and safety support into a "Center of Competence." As a Marco customer, you have access to hundreds of years of cumulative experience related to your operations.
- **Manufacturing Excellence** – Marco is a U.S. based, ISO 9001:2008 certified manufacturer of equipment for the Surface Preparation and Protective Coatings industries. Marco's engineers benchmark the industry to ensure that we design and manufacture superior products that set the "Gold Standard" for performance, safety, and quality.
- **Legendary Customer Service** – Marco's legendary customer service team is staffed by friendly, highly-trained individuals who are focused on providing the highest level of product support, order accuracy, and customer satisfaction.
- **Product Availability** – We stock over 10,000 SKU's and have over 45 shipping locations to serve North American and International markets for all major brands of blasting and painting equipment. As the largest provider of surface preparation and protective coatings equipment in the world, our inventory levels and product availability are unmatched.
- **Logistics Services** – Marco's in-house logistics team is dedicated to moving your shipment anywhere in the world. We move over 14,000 truckloads every year, allowing you to save on freight costs by leveraging our buying power. Lower your process costs with a single invoice, which includes product and freight.
- **Technology Leadership** – Our website provides: Operator's Manuals, Part Numbers and Schematics Guides, MSDS information, and Features and Specifications Guides, providing access to information 24/7. Our Extranet application allows you to receive quotes and place orders online. Our Intranet maintains a complete record of your purchase history to assist with ongoing support of your existing equipment and future purchasing decisions.

Vision Statement

Marco is the world's premier provider of Abrasives, Blasting Equipment, Coating Equipment, Engineered Systems, Rental Equipment, Safety Equipment, Service, and Repair.

Mission Statement

Marco provides strong leadership and innovation to the surface preparation and protective coatings industries. We dedicate our efforts to the continuous improvement of our products, services, processes, people, and most importantly, the quality of our customer's experience.

Quality Statement

Marco is committed to providing superior quality in the design, manufacturing, distribution, rental, service, and repair of our products. Our ISO 9001:2008 certification extends throughout all operations in all locations. Continuous improvement of our processes and supply chain Integration comprise the core of our business strategy for delivering exceptional quality and value in all Marco products and services.

Management Philosophy

We are a company dedicated to the success of every customer and associate. We discuss, debate, challenge, measure, and test our ideas. We will be boundless and limitless in our passion to improve. Through sound leadership and dedicated associates, we will ensure a long term, profitable future for Marco, our associates, customers, and suppliers.

TABLE OF CONTENTS

Company Profile	2
Table of Contents	3
Blastmaster® 151E Remote Control Switches	4-9
Part Numbers	4-5
Part Numbers and Schematics	6-7
Optional Accessories	8-10
Maintenance Notes	11

PART NUMBERS AND SCHEMATICS GUIDE

BLASTMASTER® 151E REMOTE CONTROL SWITCH				
Part Numbers	Body Material	Replaceable Switch	Electric Control Line Length	Plug
1015100	Aluminum	Yes	1.5 Ft.	None

PART NUMBERS AND SCHEMATICS GUIDE

Blastmaster® 151E Remote Control Switch



PART NUMBERS AND SCHEMATICS GUIDE

Blastmaster® 151E Remote Control Switch

Item #	Part #	Description
Fig. 1		
—	1015100	Blastmaster® 151E Remote Control Switch – Complete
1	1015001	Handle
2	1015007	3/8" O.D. x 7/16" I.D. Washer (<i>Four Required</i>)
3	1015014	8-32 x 3/8" Phillips Head Screw (<i>Four Required</i>)
4	1015101	Electric Cord Clamp
5	1015006	8-32 UNC-2B Nylon Insert Lock Nut (<i>Two Required</i>)
6	10104268	Micro Switch
7	1015015	Nylon Band - White (<i>Two Required</i>)
8	1015002	Body
9	1015008	Shoulder Screw (<i>Two Required</i>)
10	1015005	Spring (<i>Two Required</i>)
11	1015003	Safety Tab
12	1015127	Female Low Profile 4-Pin Plug (<i>Optional</i>)
—	105M063	Features and Specifications Guide – Blastmaster® 151E Remote Control Switch
—	106M063	Part Numbers and Schematics Guide – Blastmaster® 151E Remote Control Switch
—	1090063	Operator's Manual — Blastmaster® 151E Remote Control Switch
—	1091045	Hazard Identification Tag

OPTIONAL ACCESSORIES

Figure 1: Blastmaster® 151E Remote Control Switch

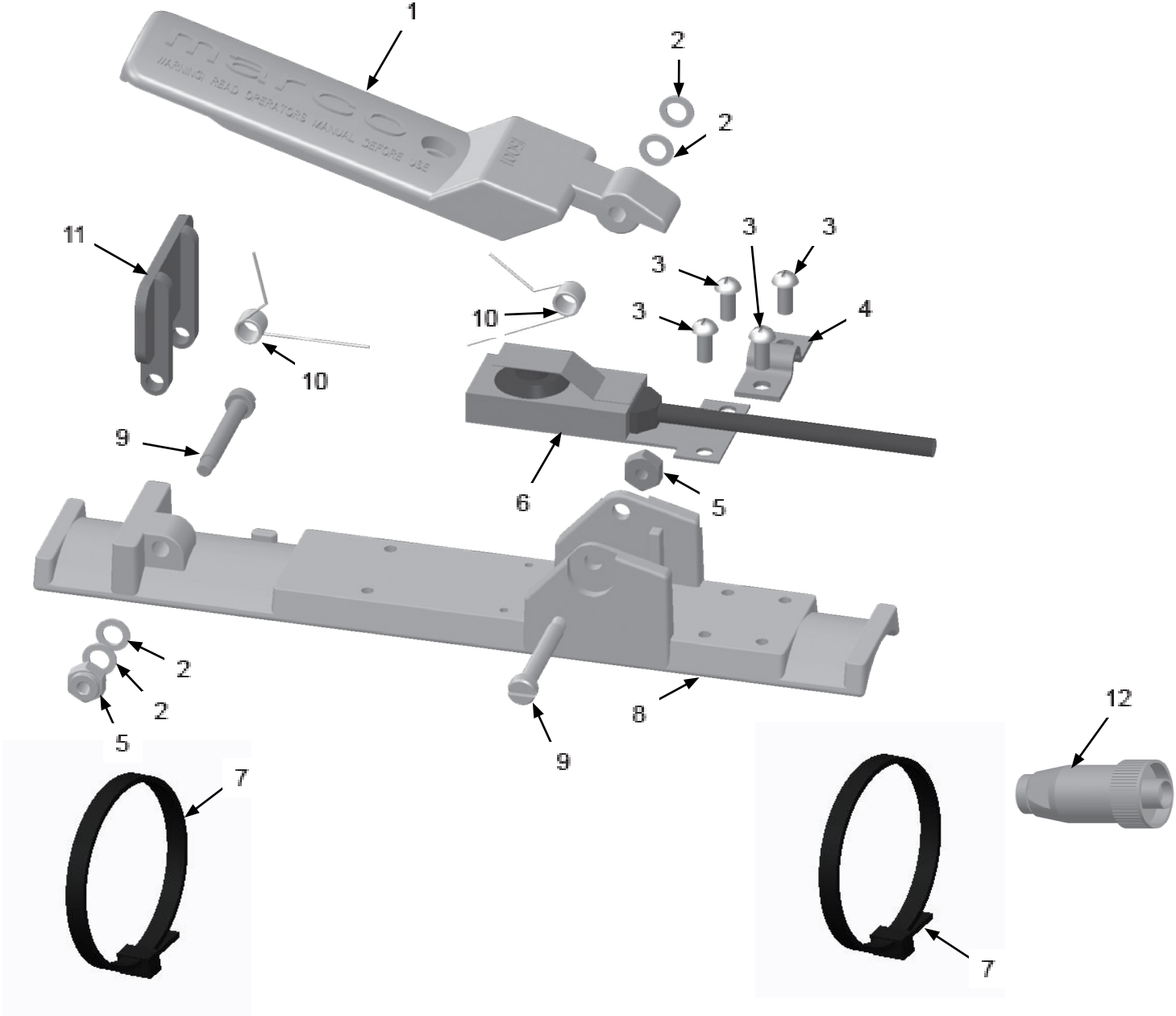

OPTIONAL ACCESSORIES











**Part
Numbers**







ELECTRIC CONTROL LINE

	Gauge	# of Wires	Type	Length
1015540	16	2	SJEOOW	Per Foot
1015701	16	3	SJEOOW	Per Foot
1030013	14	2	SEOOW	Per Foot
1015550	14	3	SEOOW	Per Foot
1015554	14	4	SEOOW	Per Foot
1015570	12	2	SOOW	Per Foot
1015571	12	3	SJEOOW	Per Foot
1015581	10	3	SEOOW	Per Foot
1015580	10	4	SEOOW	Per Foot
1015591	8	3	SEOOW	Per Foot
1015590	8	4	SEOOW	Per Foot
1015595	6	3	SEOOW	Per Foot

OPTIONAL ACCESSORIES

		ELECTRIC CONTROL LINE WITH PLUGS						
Part Numbers	Gauge	# of Wires	2-Prong Male Twist-Lock Plug	2-Prong Female Twist-Lock Plug	3-Prong Male Twist-Lock Plug	3-Prong Female Twist-Lock Plug	Length	
	1015543	16	2	1015551	1015552	—	—	25 Feet
	1015542	16	2	1015551	1015552	—	—	50 Feet
	1015546	16	2	—	—	1015555	1015556	25 Feet
	1015545	16	2	—	—	1015555	1015556	50 Feet
	1015547	16	2	—	—	1015555	1015556	100 Feet
	1015748	16	3	—	—	1015555	1015556	13 Feet
	1015745	16	3	—	—	1015555	1015556	50 Feet
	1015747	16	3	—	—	1015555	1015556	110 Feet

OPTIONAL ACCESSORIES

		ELECTRIC CONTROL LINE PLUGS	
Part Numbers		Prong Style	Plug Style
	1015551	2-Prong Male	Twist-Lock
	1015552	2-Prong Female	Twist-Lock
	1015555	3-Prong Male	Twist-Lock
	1015556	3-Prong Female	Twist-Lock
	1015126	4-Pin Male	Low-Profile
	1015127	4-Pin Female	Low-Profile

GLOBAL HEADQUARTERS

- 3425 East Locust Street
Davenport, IA 52803

ph: 800.BLAST.IT (800.252.7848)

ph: 563.324.2519

fax: 563.324.6258

GULF STATES HEADQUARTERS

- 701 East Boulevard
Deer Park, TX 77536

ph: 800.BLAST.IT (800.252.7848)

ph: 281.930.0905

fax: 281.542.0736

REGIONAL BRANCH OFFICES

- **Iowa**
Davenport
- **Louisiana**
Gonzales
Lafayette
- **Ohio**
Youngstown
- **Texas**
Beaumont
Corpus Christi
Deer Park



ABRASIVES

BLASTING

COATING

DUST COLLECTORS

ENGINEERED SYSTEMS

RENTAL

SAFETY

SERVICE & REPAIR

VACUUMS

40+ NATIONWIDE SHIPPING LOCATIONS



Marco Regional Branch Offices
and Shipping Locations

● Direct Shipping Locations

CONTACT MARCO

800.BLAST.IT

(800.252.7848)

563.324.2519

FAX: 563.324.6258

WWW.MARCO.US

SALES@MARCO.US